

# Oxford Physics Aptitude Test (PAT) 2007 Solutions

## Physics

1)

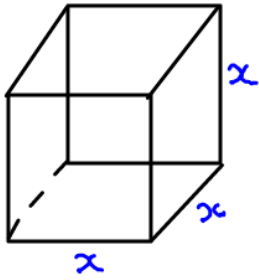

$$R = \frac{\rho l}{A} = \frac{\rho x}{x^2} = \frac{\rho}{x}$$
$$R \propto \frac{1}{x}$$

Ans: C

2) Ans: D

3)  $V = IR$

$$q = 100I$$

$$I = 0.09 \text{ A}$$

$$= 0.09 \text{ C s}^{-1}$$

$$n = \frac{0.09}{1.6 \times 10^{-19}}$$

$$= 5.625 \times 10^{17}$$

Ans: A

4)

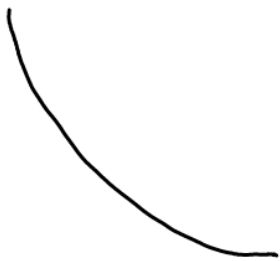

Going down  $\Rightarrow$   $v$  increases  
less steep  $\Rightarrow$   $a$  decreases

Ans: C

5)

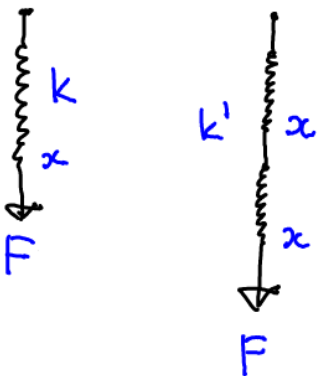

$$F = kx ; F = k'(2x)$$

$$\Rightarrow k' = \frac{k}{2}$$

Ans: A

6)  $P = \frac{V^2}{R} \Rightarrow P = \frac{V^2}{R_1} + \frac{V^2}{R_2} = V^2 \left( \frac{1}{R_1} + \frac{1}{R_2} \right)$

Ans: A

7) Ans: B

8)  $P = \frac{F}{A} = \frac{0.125 \times 10}{\pi \times (1 \times 10^{-3})^2} = 4.0 \times 10^5 \text{ Pa}$     Ans: C

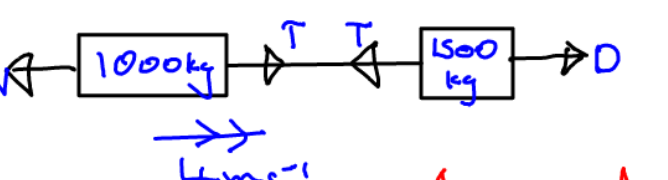
9)      $F = ma$   
 $T - 2500 = 1000(4)$   
 $T = 6500 \text{ N}$     Ans: A

10) Airport a)  $t = \frac{d}{v} = \frac{300}{170} = 1.76 \text{ h} = 106 \text{ mins}$



∴ Time of arrival: 10:46 am

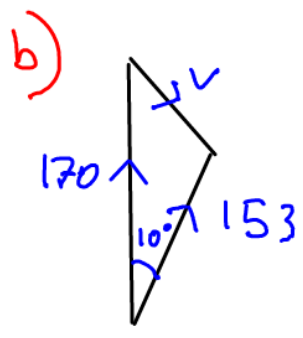

$v^2 = 170^2 + 153^2 - 2(170)(153)\cos 10$   
 $v = 32.9 \text{ km h}^{-1}$

11)

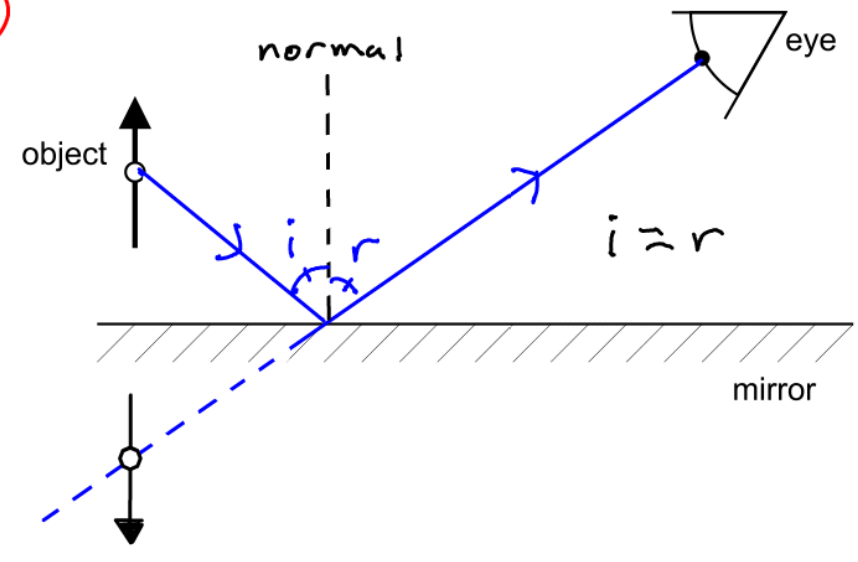

12) a)  $\Rightarrow 5m = 7v$     ①  
 b)  $\Rightarrow 3l + m = 8v$     ②  
 c)  $\Rightarrow 5l + 5m + 2v = 1$     ③

① in ②:  $3l + \frac{7v}{5} = 8v \Rightarrow 15l = 33v$     ④

⑧ and ⑨ in ③:  $5\left(\frac{33}{15}v\right) + 7v + 2v = 1$   
 $20v = 1$   
 $v = 0.05 \text{ m}$

d  $\Rightarrow$  Speed of lavender,  $V_e = 0.005 \text{ m s}^{-1}$

e  $\Rightarrow V_m = 0.01 \text{ m s}^{-1}$

$\therefore t = \frac{d}{v} = \frac{2\pi \times 1180 \times 10^3}{0.01} = 7.4 \times 10^8 \text{ s}$

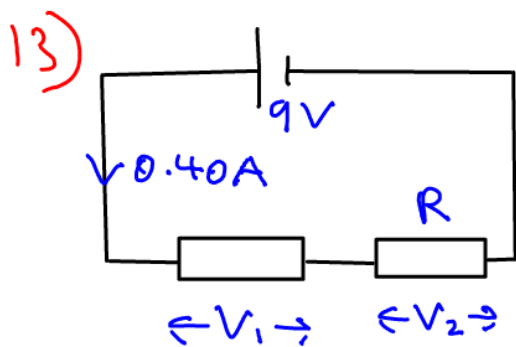

$$I = 0.05 V_1^3$$

$$\frac{0.4}{0.05} = V_1^3$$

$$V_1 = 2 \text{ V} \Rightarrow V_2 = 7 \text{ V}$$

$$R = \frac{V_2}{I} = \frac{7}{0.4} = 17.5 \Omega$$

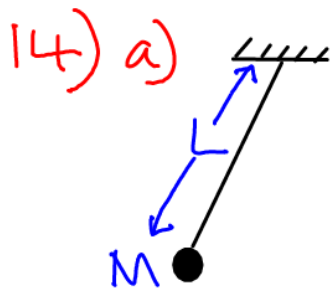

$$L_{cm} = L ; I = ML^2$$

$$\therefore P = 2\pi \sqrt{\frac{ML^2}{gML}} = 2\pi \sqrt{\frac{L}{g}}$$

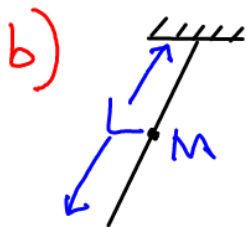

$$L_{cm} = \frac{L}{2} ; I = \frac{1}{3} ML^2$$

$$\therefore P = 2\pi \sqrt{\frac{\frac{1}{3} ML^2}{gML/2}} = 2\pi \sqrt{\frac{2L}{3g}}$$

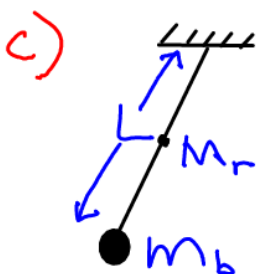

$$L_{cm} = \frac{L M_b + \frac{L}{2} M_r}{M_b + M_r}$$

(taking moments)

$$I = M_b L^2 + \frac{1}{3} M_r L^2$$

$$\therefore P = 2\pi \sqrt{\frac{\frac{L^2}{3} (3M_b + M_r)}{g(M_b + M_r) \frac{L(2M_b + M_r)}{2(M_b + M_r)}}} = 2\pi \sqrt{\frac{2L(3M_b + M_r)}{3g(2M_b + M_r)}}$$

For an ideal pendulum,  $M_r \rightarrow 0$

$$\therefore P \rightarrow 2\pi \sqrt{\frac{2L(3M_b)}{3g(2M_b)}} = 2\pi \sqrt{\frac{L}{g}}$$

For a rock pendulum,  $M_b \rightarrow 0$

$$\therefore P \rightarrow 2\pi \sqrt{\frac{2LM_r}{3gM_r}} = 2\pi \sqrt{\frac{2L}{3g}}$$

$$d) P = 2\pi \sqrt{\frac{L}{g}} \Rightarrow P' = 2\pi \sqrt{\frac{L + L\alpha\delta T}{g}}$$

$$\Delta P = P' - P = 2\pi \sqrt{\frac{L + L\alpha\delta T}{g}} - 2\pi \sqrt{\frac{L}{g}}$$

$$= 2\pi \sqrt{\frac{L}{g}} (\sqrt{1 + \alpha\delta T} - 1) = P (\sqrt{1 + \alpha\delta T} - 1)$$

For an accuracy of 1s in 24h,

$$\frac{\Delta P}{P} = \frac{1}{24 \times 60 \times 60} = \frac{P (\sqrt{1 + \alpha\delta T} - 1)}{P} = \sqrt{1 + \alpha\delta T} - 1$$

For  $\alpha = 19 \times 10^{-6}$ ;

$$\left[ \left( \frac{1}{86400} + 1 \right)^2 - 1 \right] \div 19 \times 10^{-6} = \delta T = 1.22 \text{ K}$$

$$e) \text{ For } \alpha = 1.2 \times 10^{-6}, \delta T = 19.3 \text{ K}$$

# Maths

$$1) 6667^2 - 3333^2 = (6667 + 3333)(6667 - 3333) \\ = 10000 \times 3334 = 33340000$$

$$2) y = x^4 \quad \text{At } (-2, 16), y' = -32 \\ y' = 4x^3 \\ \Rightarrow y - 16 = -32(x + 2) \\ y = -32x - 48$$

$$3) \frac{2 \log 125}{3 \log 25} = \frac{2 \log 5^3}{3 \log 5^2} = \frac{6 \log 5}{6 \log 5} = 1$$

$$4) i) (1, 5), (2, 4), (3, 3), (4, 2), (5, 1) \Rightarrow \frac{5}{36}$$

$$ii) (5, 6), (6, 5) \Rightarrow \frac{2}{36} = \frac{1}{18}$$

$$5) (2+x)^5 = 2^5 \left(1 + \frac{x}{2}\right)^5 \approx 2^5 \left[1 + \frac{5x}{2} + \frac{5(4)x^2}{2 \cdot 4} + \frac{5(4)(3)x^3}{2 \cdot 6 \cdot 2 \cdot 8}\right] \\ = 32 + 80x + 80x^2 + 40x^3$$

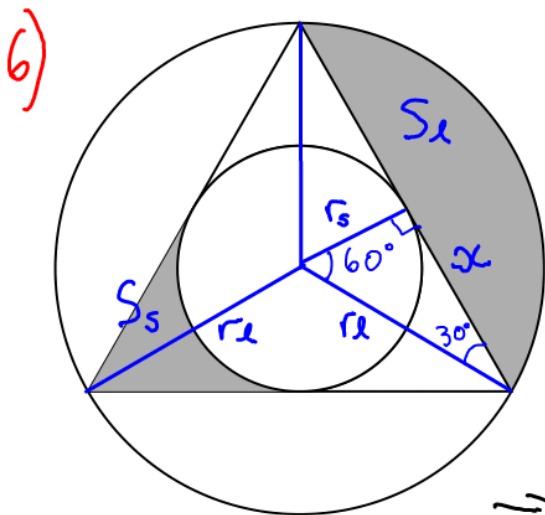

$$\sin 30 = \frac{r_s}{r_e} = \frac{1}{2} \Rightarrow r_e = 2r_s *$$

$$i) \frac{A_e}{A_s} = \frac{\pi r_e^2}{\pi r_s^2} = \left(\frac{r_e}{r_s}\right)^2 = 2^2 = 4$$

$$ii) \text{Height of triangle} = r_e + r_s$$

$$x = r_e \cos 30 = \frac{\sqrt{3}}{2} r_e$$

$$\Rightarrow \text{Area of triangle} = \frac{1}{2} \times \sqrt{3} r_e (r_e + r_s) = K$$

$$S_s = \frac{K - A_s}{3}; \quad S_e = \frac{A_e - K}{3}$$

$$\Rightarrow \frac{S_e}{S_s} = \frac{A_e - K}{K - A_s} = \frac{\pi r_e^2 - \frac{\sqrt{3}}{2} r_e^2 - \frac{\sqrt{3}}{2} r_e r_s}{\frac{\sqrt{3}}{2} r_e^2 + \frac{\sqrt{3}}{2} r_e r_s - \pi r_s^2}$$

using \*

$$= \frac{2\pi(4r^2) - \sqrt{3}(4r^2) - \sqrt{3}(2r^2)}{\sqrt{3}(4r^2) + \sqrt{3}(2r^2) - 2\pi r^2}$$

$$= \frac{8\pi - 6\sqrt{3}}{6\sqrt{3} - 2\pi} = \frac{4\pi - 3\sqrt{3}}{3\sqrt{3} - \pi}$$

7)

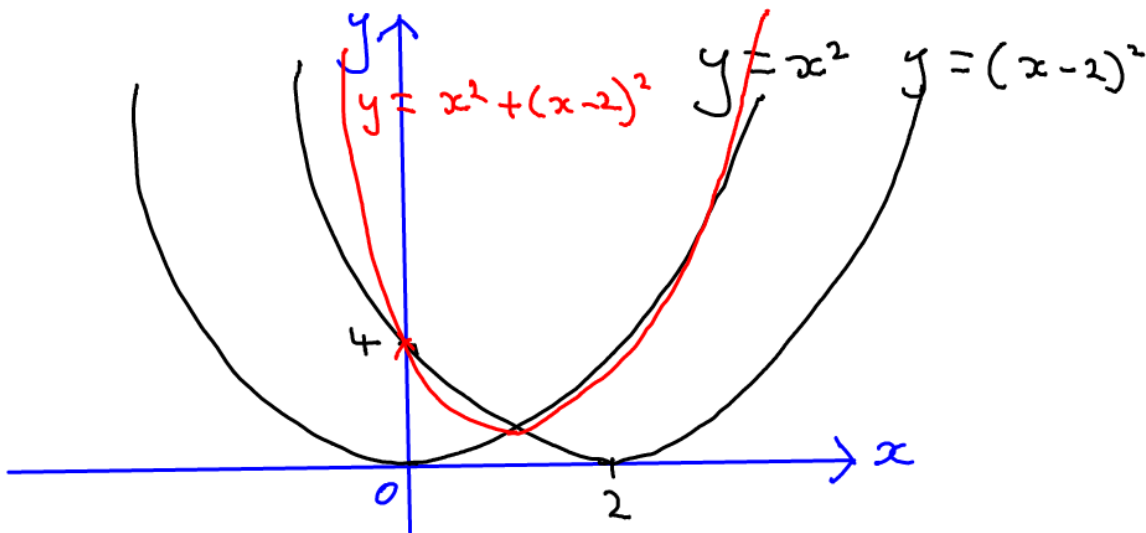

8)  $\tan \theta = 2 \sin \theta$ ,  $0 \leq \theta \leq 2\pi$

$$\sin \theta = 2 \sin \theta \cos \theta$$

$$0 = \sin \theta (2 \cos \theta - 1)$$

$$\sin \theta = 0 \quad \text{or} \quad 2 \cos \theta - 1 = 0$$

$$\cos \theta = \frac{1}{2}$$

$$\theta = 0, \pi, 2\pi$$

$$\theta = \frac{\pi}{3}, \frac{5\pi}{3}$$

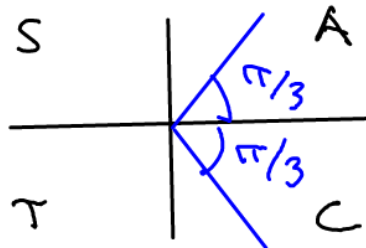

$$\theta = 0, \frac{\pi}{3}, \pi, \frac{5\pi}{3}, 2\pi$$

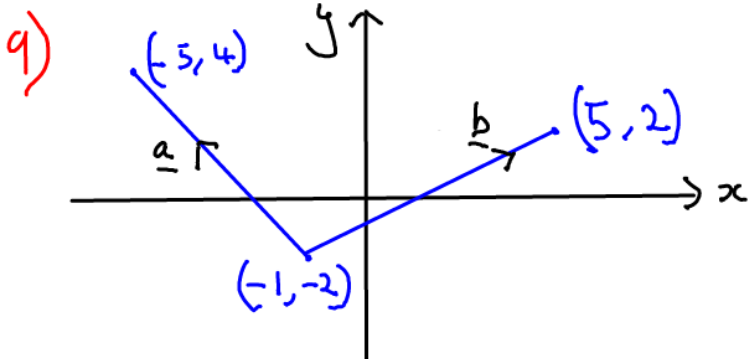

$$\text{Let } \underline{a} = \begin{pmatrix} -5 \\ 4 \end{pmatrix} - \begin{pmatrix} -1 \\ -2 \end{pmatrix} = \begin{pmatrix} -4 \\ 6 \end{pmatrix}$$

$$\underline{b} = \begin{pmatrix} 5 \\ 2 \end{pmatrix} - \begin{pmatrix} -1 \\ -2 \end{pmatrix} = \begin{pmatrix} 6 \\ 4 \end{pmatrix}$$

$$|\underline{a}| = \sqrt{(-4)^2 + 6^2} = \sqrt{52}$$

$$|\underline{b}| = \sqrt{6^2 + 4^2} = \sqrt{52} = |\underline{a}|$$

$\underline{a} \cdot \underline{b} = -24 + 24 = 0$   $\therefore$  Two sides are perpendicular and have the same length

Fourth corner:  $\begin{pmatrix} -5 \\ 4 \end{pmatrix} + \begin{pmatrix} 6 \\ 4 \end{pmatrix} = \begin{pmatrix} 1 \\ 8 \end{pmatrix}$  Area =  $(\sqrt{52})^2 = 52$

$$10) \int_1^9 \left( \sqrt{x} + \frac{1}{\sqrt{x}} \right) dx = \int_1^9 \left( x^{1/2} + x^{-1/2} \right) dx = \left[ \frac{2}{3} x^{3/2} + 2 x^{1/2} \right]_1^9$$

$$= (18 + 6) - \left( \frac{2}{3} + 2 \right) = \frac{64}{3}$$

$$11) ar = a + d \Rightarrow d = a(r-1)$$

$$ar^2 = 2(a+2d) \Rightarrow d = \frac{a(r^2-2)}{4}$$

$$a(r-1) = \frac{a(r^2-2)}{4}$$

$$4r - 4 = r^2 - 2$$

$$r^2 - 4r + 2 = 0$$

$$r = \frac{4 \pm \sqrt{16-8}}{2} = 2 \pm \sqrt{2}$$

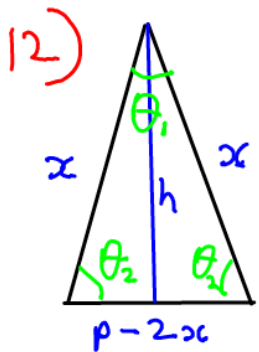

$$h^2 + \left( \frac{p-2x}{2} \right)^2 = x^2$$

$$h = \left[ x^2 - \frac{1}{4} (p-2x)^2 \right]^{1/2}$$

$$A = \frac{1}{2} (p-2x)h = \frac{1}{2} (p-2x) \left[ x^2 - \frac{1}{4} (p-2x)^2 \right]^{1/2}$$

$$= \frac{1}{2} (p-2x) \left[ x^2 - \frac{p^2}{4} - x^2 + px \right]^{1/2}$$

$$= \frac{1}{2} (p-2x) \left[ \frac{1}{4} (4px - p^2) \right]^{1/2}$$

$$= \frac{1}{4} (p-2x) (4px - p^2)^{1/2}$$

$$\frac{dA}{dx} = \frac{1}{4} (p-2x) \frac{1}{2} (4px - p^2)^{-1/2} \cdot 4p - \frac{1}{2} (4px - p^2)^{1/2} = 0$$

$$p(p-2x) = 4px - p^2 \Rightarrow x = \frac{p}{3}$$

$$\cos \theta_2 = \frac{\frac{1}{2} \left( p - \frac{2p}{3} \right)}{p/3}$$

$$\theta_2 = 60^\circ$$

$$\theta_1 = 180 - (2 \times 60) = 60^\circ$$